

## HOOFDSTUK A

## LUIDSPREKERTRANSFORMATOREN

INLEIDING

De pagina's van dit hoofdstuk, zijn ingedeeld als volgt :

Inleiding en algemene richtlijnen	A-a-1; A-a-2 enz.
Overzicht van codenummers van de te vervangen transformatoren, gevolgd door de codenummers van de standaardtransformatoren	A-b-1; A-b-2 enz.
Overzicht van codenummers van de standaardtransformatoren, gevolgd door de codenummers van de te vervangen transformatoren	A-c-1; A-c-2 enz.
Figuren van de standaardtransformatoren	A-d-1; A-d-2 enz.
Figuren van de te vervangen transformatoren	A-e-1; A-e-2 enz.
Overzicht van typenummers van ontvangers met de hierin toegepaste originele luidspreker-transformatoren	A-f-1; A-f-2 enz.

ALGEMENE RICHTLIJNEN

Op de bladen A-b-1, A-b-2 enz. kan men voor een te vervangen transformator het codenummer van de standaardtransformator vinden. Ook de plaats, waar de originele transformator getekend is, is hierop aangegeven.

Op het vouwblad A-d-1, zijn de aansluitingen van de standaardtransformator getekend. De contactlippen zijn evenals die van de originele transformator genummerd. Deze nummers zijn te allen tijde overeenkomstig. De verbindingsdraad (of draden) verbonden aan de lip genummerd 1 bij de originele transformator, wordt aan lip 1 van de standaardtransformator bevestigd. Punt 2 aan 2 enz.

Indien 2 contactpunten op de standaardtransformator moeten worden doorverbonden, is dit aangegeven onder de figuren van de originele transformatoren.

Het zal U opvallen, dat in deze nieuwe uitgave de bladen A-f-1, A-f-2-enz. toegevoegd zijn.

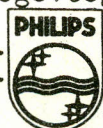



## PHILIPS SERVICE

De reden hiervan is de volgende:

Door gebruik van nieuw materiaal, werkmethode etc. is het mogelijk geworden, betere transformatoren in een kleiner volume te fabriceren. Deze nieuwe mogelijkheden zullen ook op de standaard-transformatoren worden toegepast. Doordat het volume kleiner is, kunnen oude vorm en plaats van de aansluitlippen niet gehandhaafd blijven. Bovendien zullen de "oude" standaardtransformatoren op de duur ook vervangen worden.

Hierbij kan het voorkomen, dat een "oude" standaardtransformator vervangen wordt door 2 of 3 van de nieuwe uitvoering, waardoor een directe verwijzing niet mogelijk is. Daaren-boven is in de stuklijst van vele service-documentaties, niet het originele nummer maar dat van de standaardtransformator vermeld.

Om aan deze moeilijkheid tegemoet te komen, zijn de bladen A-f-1, A-f-2 toegevoegd. Hierin zijn vermeld, de type-nummers van apparaten gevolgd door het code-nummer van de hierin toegepaste originele transformatoren.

xxx

Om U erop attent te maken, dat een "oude" standaard (die U in de documentatie vindt) vervangen moet worden, zijn deze ook op de bladen A-b-1, A-b-2 enz. opgenomen, echter niet gevolgd door een vervangings-nummer. Dit is voor U het teken, dat U op de bladen A-f-1, A-f-2 enz. eerst het originele nummer op moet zoeken. Hierna kan weer de normale procedure gevolgd worden.

### VOORBEELD

Luidspreker-transformator A3 151 64.

De transformator kan worden gevonden in het overzicht van de originele transformatoren, in dit geval op blad A-b-1. Achter de transformator staat pagina A-e-1, tekening no. 17. Tevens is achter het codenummer de standaard gegeven, nl. 918/06.

Voor het vervangen gaat men nu als volgt te werk:

De verbindingsdraad (of draden) verbonden aan de lip, genummerd 1 bij de originele transformator, wordt aan lip 1 van de standaardtransformator bevestigd.

De verbindingsdraad (of draden) verbonden aan lip 2, aan 2.

Op deze wijze verbinden wij dus alle aansluitdraden van de originele transformator met deze van de standaard.

Nog enkele punten waarop gelet moet worden, zijn:

1. Indien onder de tekening van de originele transformator bijvoorbeeld 7+8 staat, betekent dit dat deze punten op de standaardtransformator, moeten worden doorverbonden.

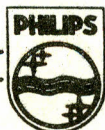



**PHILIPS SERVICE**

2. Bij sommige te vervangen transformatoren vindt men meer contact-punten dan op de tekening gegeven zijn. De niet op de tekening voorkomende lippen zijn steunpunten en dus niet met de spoel verbonden. Op de standaardtransformator zijn dergelijke steunpunten niet aanwezig. Er moet dus een ander bevestigingspunt gezocht worden.
3. Een merkstip op de transformator geeft het begin van de primaire spoel aan. Als na het inbouwen van de standaardtransformator een fluittoon optreedt (genereren), dan controleer men de aansluitdraden, om na te gaan of begin en einde van de wikkeling niet zijn verwisseld.
4. Indien bij apparaten, waarvan de originele transformator voorzien is van een anti-brom wikkeling, na vervanging brom optreedt, moet in serie met de anti-brom wikkeling een weerstand van 410  $\Omega$  worden opgenomen (2x A9 999 00/820E par.).
5. De afmetingen van de standaardtransformator kunnen iets afwijken van die der originele. Het kan in die gevallen nodig zijn, een gat in het chassis te boren of de bedrading iets te verleggen.
6. "Oude" standaardtransformatoren opgebruiken volgens richtlijnen vorige editie.

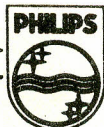





## PHILIPS SERVICE

INDEX

Code nr.	Blad	Fig.nr.	Vervanger
A3 151 04	A-e-1	I	918/04
09	A-e-1	II	918/04
12	A-e-1	III	918/04
13	A-e-1	IV	918/07
15	A-e-1	V	918/04
16	A-e-1	VI	918/04
26	A-e-1	VII	918/04
36	A-e-1	VIII	918/03
39	A-e-1	IX	918/04
42	A-e-1	X	918/04
47	A-e-1	XI	918/04
52	A-e-1	XII	918/04
53	Zie pag. A-a-2		xxx
54	" "	" "	xxx
55	" "	" "	xxx
57	A-e-1	XIII	918/03
58	A-e-1	XIV	918/06
60	A-e-1	XV	918/05
61	A-e-1	XVI	918/03
64	A-e-1	XVII	918/06
65	A-e-1	XVIII	918/06
68	A-e-1	XIX	918/05
70	A-e-1	XX	918/04
71	A-e-1	XXI	918/09
72	A-e-1	XXII	918/09
74	A-e-1	XXIII	918/04
82	A-e-1	XXIV	918/03
85	A-e-2	I	918/04
87	A-e-2	II	918/06
91	A-e-2	III	918/04
93	A-e-2	IV	918/04
95	A-e-2	V	918/06
97	A-e-2	VI	918/03
99	A-e-2	VII	918/03
A3 152 02	A-e-2	VIII	918/01
04	A-e-2	IX	918/04
05	A-e-2	X	918/07
06	A-e-2	XI	918/05
09	A-e-2	XII	918/04
11	A-e-2	XIII	918/03
17	A-e-2	XIV	918/03
18	A-e-2	XV	918/04
19	A-e-2	XVI	918/01
24	A-e-2	XVII	918/03

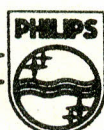



## PHILIPS SERVICE

INDEX

Code nr.	Blad	Fig. nr.	Vervanger
A3 152 29	A-e-2	XVIII	918/04
30	A-e-2	XIX	918/04
32	A-e-2	XX	918/07
34	A-e-2	XXI	918/06
35	A-e-2	XXII	918/01
37	A-e-3	I	918/04
40	A-e-3	II	918/05
41	A-e-3	III	918/09
42	A-e-3	IV	918/04
44	A-e-3	V	918/03
46	<b>Zie pag. A-a-2</b>		xxx
47	A-e-3	VI	918/03
48	A-e-3	VII	918/03
50	A-e-3	VIII	918/09
52	A-e-3	IX	918/03
57	A-e-3	X	918/04
61	A-e-3	XI	918/05
62	A-e-3	XII	918/04
63	A-e-3	XIII	918/05
64	A-e-3	XIV	918/05
67	A-e-3	XV	918/04
69	A-e-3	XVI	918/03
74	A-e-3	XVII	918/03
75	A-e-3	XVIII	918/09
76	A-e-3	XIX	918/07
78	A-e-3	XX	918/07
79	A-e-3	XXI	918/09
87	A-e-3	XXII	918/03
88	A-e-3	XXIII	918/03
89	A-e-3	XXIV	918/09
91	A-e-4	I	918/03
92	A-e-4	II	918/09
95	A-e-4	III	918/03
96	A-e-4	IV	918/03
98	A-e-4	V	918/03
99	A-e-4	VI	918/07
A3 153 02	A-e-4	VII	918/05
03	A-e-4	VIII	918/07
04	A-e-4	IX	918/03
06	A-e-4	X	918/07
08	A-e-4	XI	918/08
09	A-e-4	XII	918/03
11	A-e-4	XIII	918/03
14	A-e-4	XIV	918/03
16	A-e-4	XV	918/03

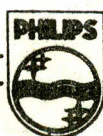



# PHILIPS SERVICE

## INDEX

Code nr.	Blad	Fig. nr.	Vervanger
A3 153 17	A-e-4	XVI	918/03
18	A-e-4	XVII	918/08
19	A-e-4	XVIII	918/05
21	A-e-4	XIX	918/07
22	A-e-4	XX	918/03
23	A-e-4	XXI	918/07
24	A-e-4	XXII	918/03
25	A-e-4	XXIII	918/08
26	A-e-4	XXIV	918/03
27	A-e-5	I	918/04
28	A-e-5	II	918/03
29	A-e-5	III	918/04
30	A-e-5	IV	918/03
31	A-e-5	V	918/09
33	A-e-5	VI	918/03
34	A-e-5	VII	918/04
35	A-e-5	VIII	918/03
37	A-e-5	XI	918/08
38	A-e-5	X	918/05
40	A-e-5	XI	918/03
41	A-e-5	XII	918/03
42	A-e-5	XIII	918/09
44	A-e-5	XIV	918/09
45	A-e-5	XV	918/09
46	A-e-5	XVI	918/04
47	A-e-5	XVII	918/09
52	A-e-5	XVIII	918/04
56	A-e-5	XIX	918/07
57	A-e-5	XX	918/03
58	A-e-5	XXI	918/04
61	A-e-5	XXII	918/09
62	A-e-5	XXIII	918/03
63	A-e-5	XXIV	918/03
64	A-e-6	I	918/04
66	A-e-6	II	918/03
67	A-e-6	III	918/09
69	A-e-6	IV	918/09
A3 168 50	A-e-6	V	918/04
53	A-e-6	VI	918/04
54	A-e-6	VII	918/04
56	A-e-6	VIII	918/06
59	A-e-6	IX	918/05
62	A-e-6	X	918/04
63	A-e-6	XI	918/04
64	A-e-6	XII	918/06
66	A-e-6	XIII	918/05





## PHILIPS SERVICE

INDEX

Code nr.	Blad	Fig. nr.	Vervanger	
A3 168	68	A-e-6	XV	918/06
	70	A-e-6	XVI	918/05
	74	A-e-6	XVII	918/06
	75	A-e-6	XIX	918/04
	77	A-e-6	XX	918/06
	81	A-e-6	XXI	918/09
	82	A-e-6	XXII	918/04
	83	A-e-6	XXIII	918/06
	87	A-e-6	XXIV	918/03
	88	A-e-7	I	918/04
	91	A-e-7	II	918/03
	93	A-e-7	III	918/03
	94	A-e-7	IV	918/09
	95	A-e-7	V	918/04
	96	A-e-7	VI	918/06
	97	A-e-7	VII	918/04
	98	A-e-7	VIII	918/01
A3 169	00	A-e-7	IX	918/06
	01	A-e-7	X	918/04
	02	A-e-7	XI	918/09
	03	A-e-7	XII	918/03
	04	A-e-7	XIII	918/04
	05	A-e-7	XIV	918/06
	06	A-e-7	XV	918/04
	07	A-e-7	XVI	918/04
	08	A-e-7	XVII	918/03
	09	A-e-7	XVIII	918/05
	10	A-e-7	XIX	918/01
	11	A-e-7	XX	918/03
	12	A-e-7	XXI	918/04
	13	A-e-7	XXII	918/04
	16	A-e-7	XXIII	918/03
	17	A-e-7	XXIV	918/01
	19	Zie pag.	A-a-2	xxx
	20	" "	"	xxx
	22	A-e-8	I	918/04
	23	A-e-8	II	918/04
	24	A-e-8	III	918/01
	26	A-e-8	IV	918/05
	27	A-e-8	V	918/04
	30	A-e-8	VI	918/03
	31	A-e-8	VII	918/07
	32	A-e-8	VIII	918/04
	33	A-e-8	IX	918/01
	35	A-e-8	X	918/05
	38	A-e-8	XI	918/03

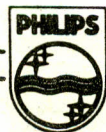



# PHILIPS SERVICE

## INDEX.

Code nr.	Blad	Fig. nr.	Vervanger
A3 169 39	A-e-8	XII	918/04
41	A-e-8	XIII	918/05
42	A-e-8	XIV	918/03
43	A-e-8	XV	918/04
45	A-e-8	XVI	918/05
46	A-e-8	XVII	918/05
47	A-e-8	XVIII	918/06
49	A-e-8	XIX	918/03
50	A-e-8	XX	918/04
53	A-e-8	XXI	918/03
54	A-e-8	XXII	918/04
55	A-e-8	XXIII	918/04
56	A-e-8	XXIV	918/04
57	A-e-9	I	918/07
58	A-e-9	II	918/04
59	A-e-9	III	918/07
60	A-e-9	IV	918/05
61	A-e-9	V	918/04
62	A-e-9	VI	918/03
63	A-e-9	VII	918/04
64	A-e-9	VIII	918/05
65	A-e-9	IX	918/04
66	A-e-9	X	918/03
67	A-e-9	XI	918/05
69	A-e-9	XII	918/03
70	A-e-9	XIII	918/04
71	A-e-9	XIV	918/07
72	A-e-9	XV	918/03
73	A-e-9	XVI	918/03
75	A-e-9	XVII	918/08
76	<b>Zie pag. A-a-2</b>		xxx
77	A-e-9	XVIII	918/04
78	A-e-9	XIX	918/04
79	A-e-9	XX	918/03

HT/GH

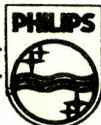



## PHILIPS SERVICE

INDEX

Vervanger	Origineel	Vervanger	Origineel
A9 999 18/01	A3 152 02	A9 999 18/03	A3 153 30
	A3 152 19		A3 153 33
	* A3 168 98		A3 153 35
	A3 169 10		A3 153 40
	A3 169 17		A3 153 41
	A3 169 24		A3 153 57
	A3 169 33		A3 153 62
	* A3 152 35		A3 153 63
			A3 153 66
A9 999 18/03	A3 151 36		A3 168 87
	A3 151 57		A3 168 91
	A3 151 61		A3 168 93
	A3 151 82		A3 169 03
	A3 151 97		A3 169 08
	A3 151 99		A3 169 11
	A3 152 11		A3 169 16
	A3 152 17		A3 169 30
	A3 152 24		A3 169 38
	A3 152 44		A3 169 42
	A3 152 47		A3 169 49
	A3 152 48		A3 169 53
	A3 152 52		A3 169 62
	A3 152 69		A3 169 66
	A3 152 74		A3 169 69
	A3 152 87		A3 169 72
	A3 152 88		A3 169 73
	A3 152 91		A3 169 79
	A3 152 95		
	A3 152 96		
	A3 152 98	A9 999 18/04	A3 151 04
	A3 153 04		A3 151 09
	A3 153 09		A3 151 12
	A3 153 11		A3 151 15
	A3 153 14		A3 151 16
	A3 153 16		A3 151 26
	A3 153 17		A3 151 39
	A3 153 22		A3 151 42
	A3 153 24		A3 151 47
	A3 153 26		A3 151 52
	A3 153 28		A3 151 70

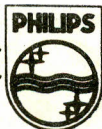



## PHILIPS SERVICE

Vervanger	Origineel	Vervanger	Origineel
A9 999 18/04	A3 151 74	A9 999 18/04	A3 169 32
	A3 151 85		A3 169 39
	A3 151 91		A3 169 43
	A3 151 93		A3 169 50
	A3 152 04		A3 169 54
	A3 152 09		A3 169 55
	A3 152 18		A3 169 56
	A3 152 29		A3 169 58
	A3 152 30		A3 169 61
	A3 152 37		A3 169 63
	A3 152 42		A3 169 65
	A3 152 57		A3 169 70
	A3 152 62		A3 169 77
	A3 152 67		A3 169 78
	A3 153 27		
	A3 153 29		
	A3 153 34	A9 999 18/05	A3 151 60
	A3 153 46		A3 151 68
	A3 153 52		A3 152 06
	A3 153 58		A3 152 40
	A3 153 64		A3 152 61
	A3 168 50		A3 152 63
	A3 168 53		A3 152 64
	A3 168 54		A3 153 02
	A3 168 62		A3 153 19
	A3 168 63		A3 153 38
	A3 168 75		A3 168 59
	A3 168 82		A3 168 66
	A3 168 88		A3 168 70
	A3 168 95		A3 169 09
	A3 168 97		A3 169 26
	A3 169 01		A3 169 35
	A3 169 04		A3 169 41
	A3 169 06		A3 169 45
	A3 169 07		A3 169 46
	A3 169 12		A3 169 60
	A3 169 13		A3 169 64
	A3 169 22		A3 169 67
	A3 169 23		
	A3 169 27		





## PHILIPS SERVICE

INDEX

Vervanger	Origineel	Vervanger	Origineel
A9 999 18/06	A3 151 58	A9 999 18/08	A3 153 08
	A3 151 64		A3 153 18
	A3 151 65		A3 153 25
	A3 151 87		A3 153 37
	A3 151 95		A3 169 75
	A3 152 34		
	A3 168 56	A9 999 18/09	A3 151 71
	A3 168 64		A3 151 72
	A3 168 68		A3 152 41
	A3 168 74		A3 152 50
	A3 168 77		A3 152 75
	A3 168 83		A3 152 79
	A3 168 96		A3 152 89
	A3 169 00		A3 152 92
	A3 169 05		A3 153 31
	A3 169 47		A3 153 42
A9 999 18/07	A3 151 13		A3 153 44
	A3 152 05		A3 153 45
	A3 152 32		A3 153 47
	A3 152 76		A3 153 61
	A3 152 78		A3 153 67
	A3 152 99		A3 153 69
	A3 153 03		A3 168 81
	A3 153 06		A3 168 94
	A3 153 21		A3 169 02
	A3 153 23		
	A3 153 56		
	A3 169 31		
	A3 169 57		
	A3 169 59		
	A3 169 71		

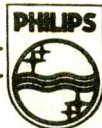



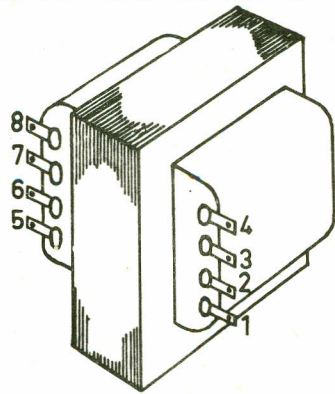

A9 999 18 / 01

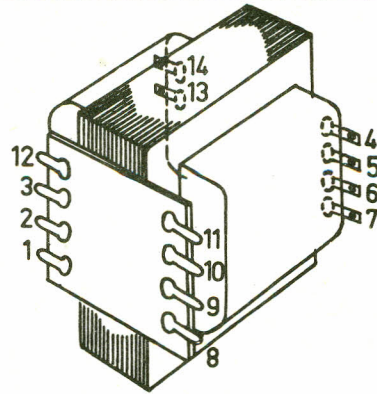

A9 999 18 / 03

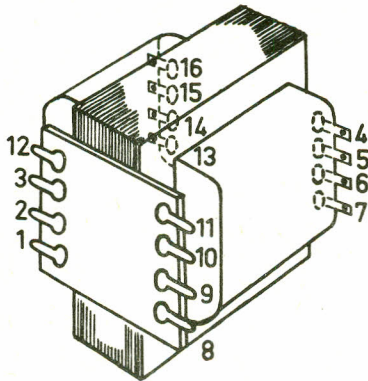

A9 999 18 / 04

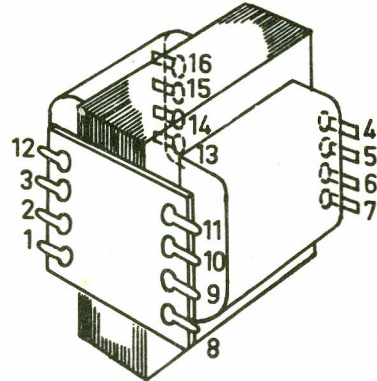

A9 999 18 / 05

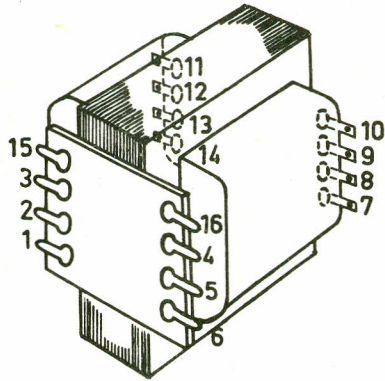

A9 999 18 / 06

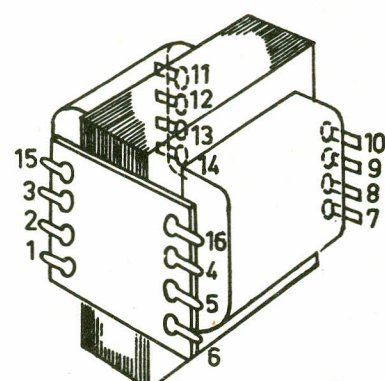

A9 999 18 / 07

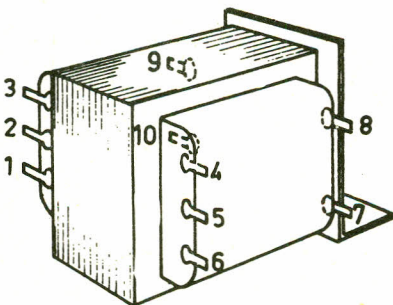

A9 999 18 / 08

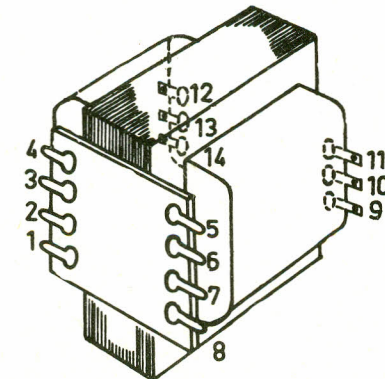

A9 999 18 / 09





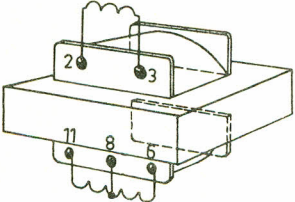
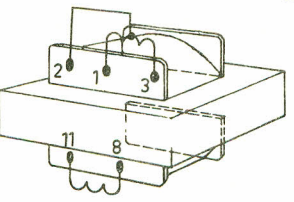
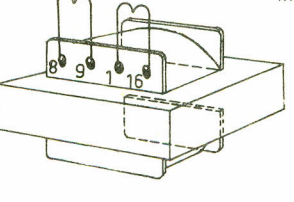
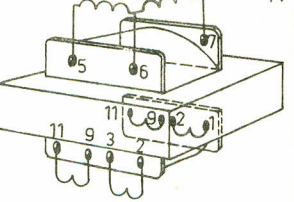
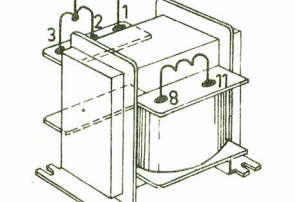
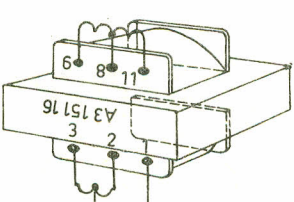
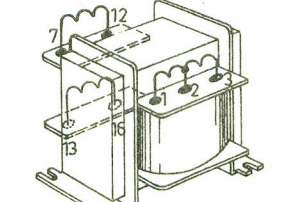
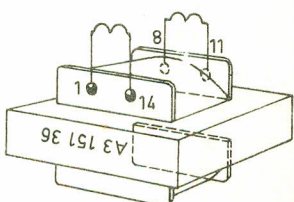
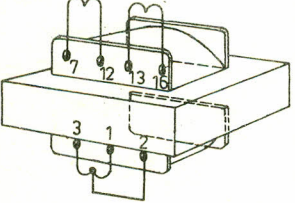
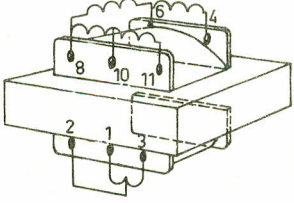
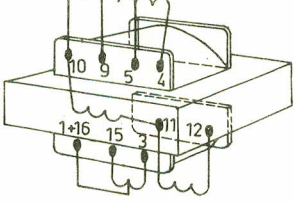
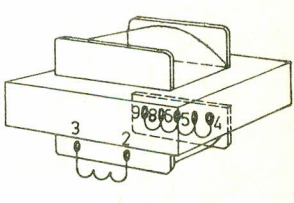
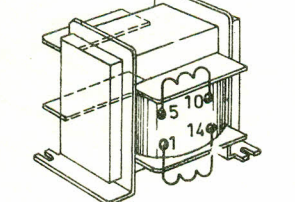
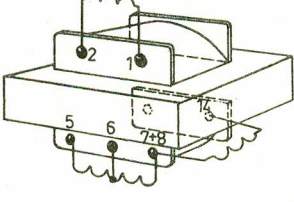
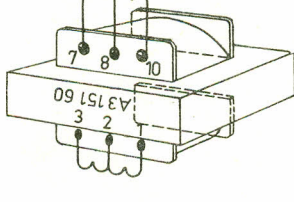
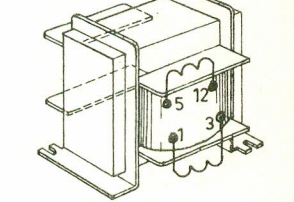
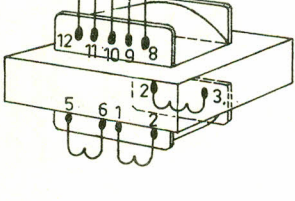
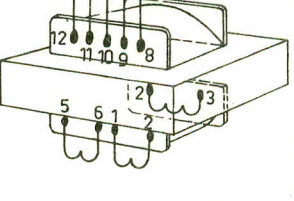
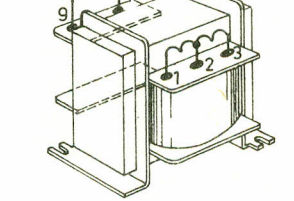
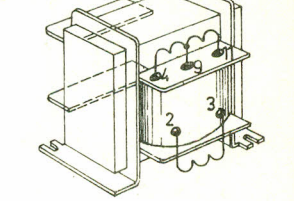
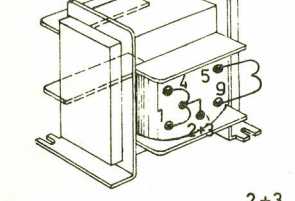
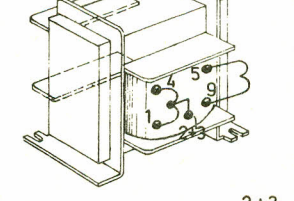
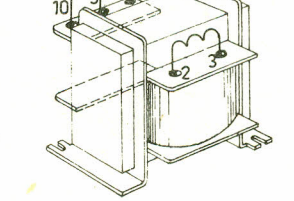
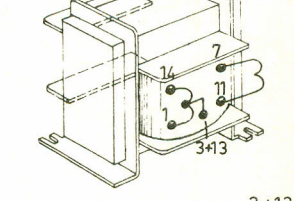

 <p>I A3 151 04</p>	 <p>II A3 151 09</p>	 <p>III A3 151 12 3+13</p>	 <p>IV A3 151 13</p>
 <p>V A3 151 15</p>	 <p>VI A3 151 16</p>	 <p>VII A3 151 26</p>	 <p>VIII A3 151 36 3+13</p>
 <p>IX A3 151 39</p>	 <p>X A3 151 42</p>	 <p>XI A3 151 47 7+8 1+16</p>	 <p>XII A3 151 52</p>
 <p>XIII A3 151 57 3+13</p>	 <p>XIV A3 151 58 7+8</p>	 <p>XV A3 151 60</p>	 <p>XVI A3 151 61</p>
 <p>XVII A3 151 64</p>	 <p>XVIII A3 151 65</p>	 <p>XIX A3 151 68</p>	 <p>XX A3 151 70</p>
 <p>XXI A3 151 71 2+3</p>	 <p>XXII A3 151 72 2+3</p>	 <p>XXIII A3 151 74</p>	 <p>XXIV A3 151 82 3+13</p>



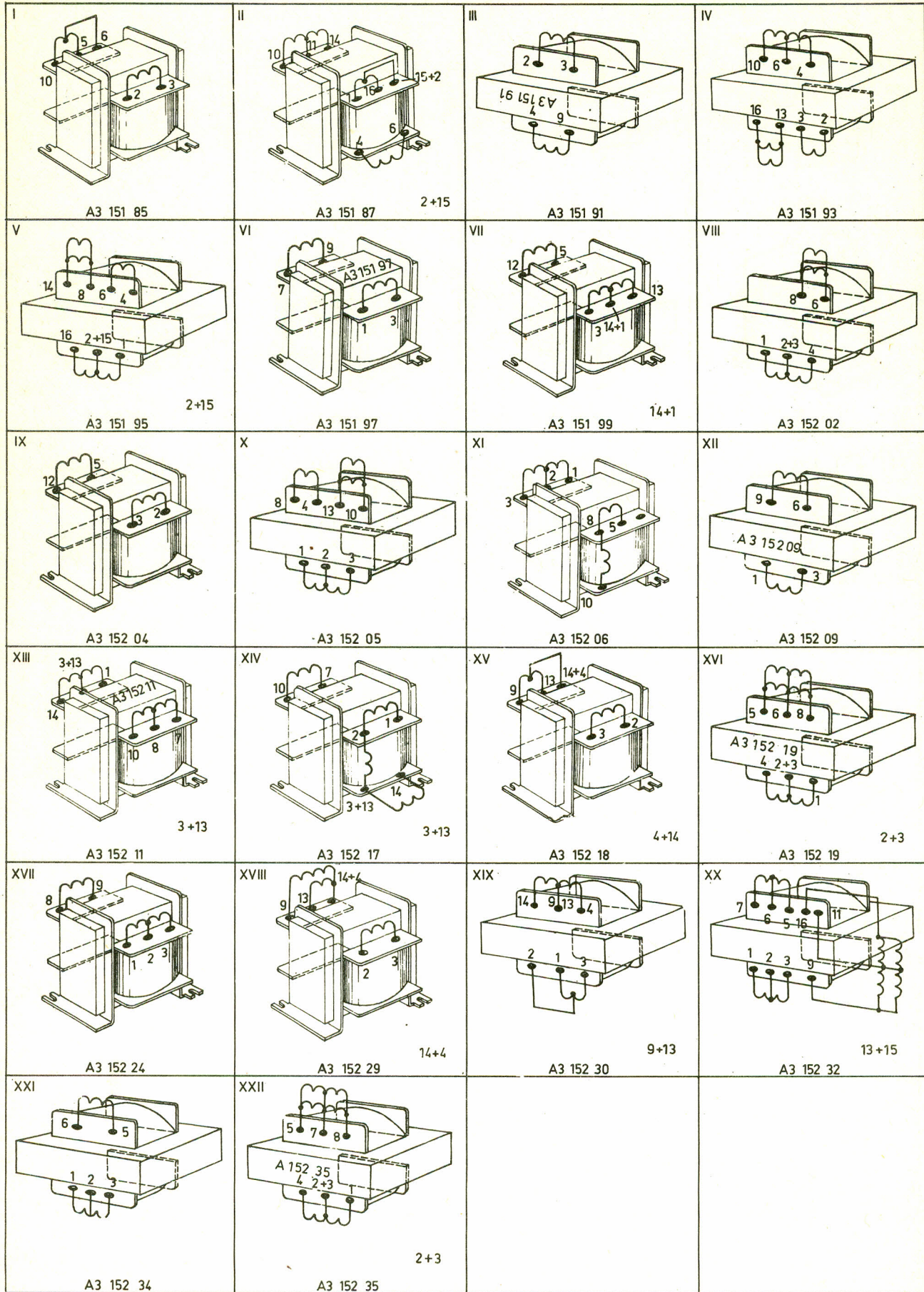

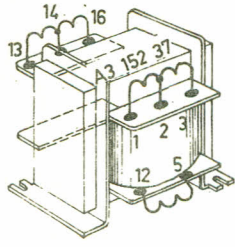
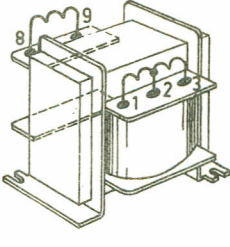
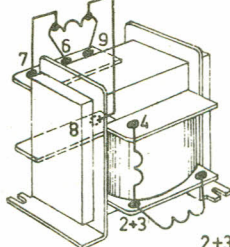
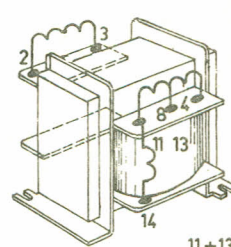
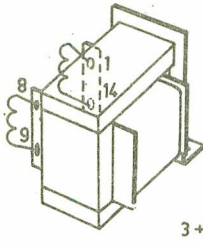
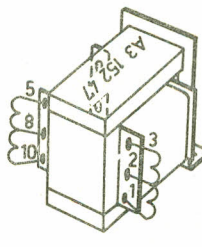
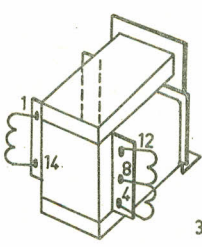
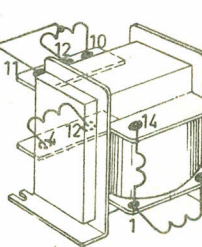
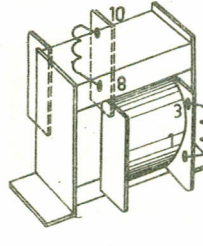
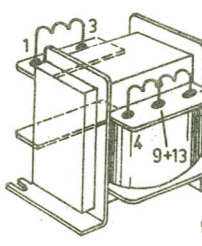
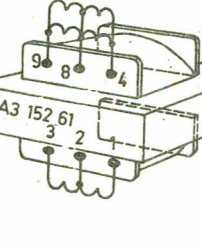
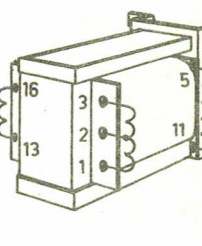
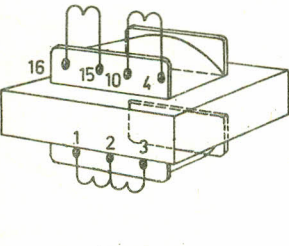
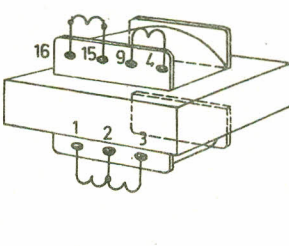
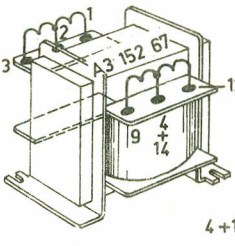
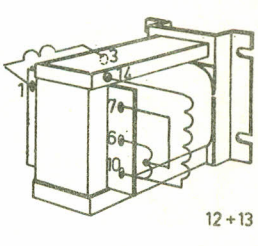
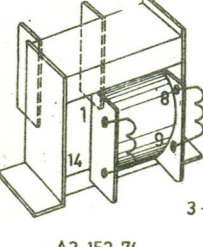
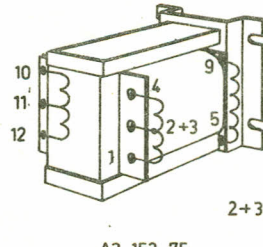
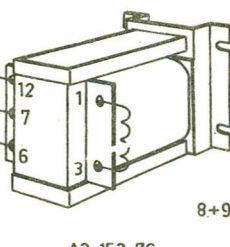
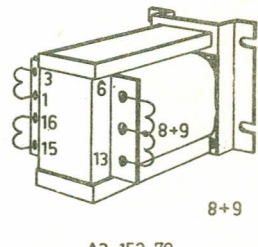
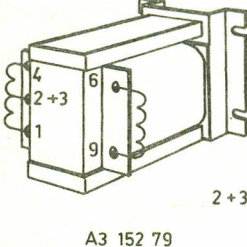
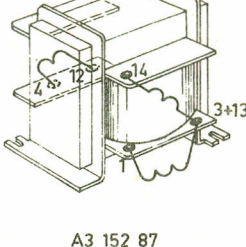
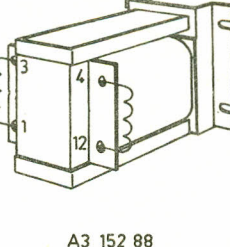
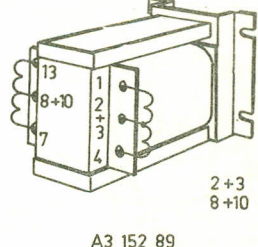

 <p>I A3 152 37</p>	 <p>II A3 152 40</p>	 <p>III A3 152 41</p>	 <p>IV A3 152 42</p>
 <p>V A3 152 44</p>	 <p>VI A3 152 47</p>	 <p>VII A3 152 48</p>	 <p>VIII A3 152 50</p>
 <p>IX A3 152 52</p>	 <p>X A3 152 57</p>	 <p>XI A3 152 61</p>	 <p>XII A3 152 62</p>
 <p>XIII A3 152 63</p>	 <p>XIV A3 152 64</p>	 <p>XV A3 152 67</p>	 <p>XVI A3 152 69</p>
 <p>XVII A3 152 74</p>	 <p>XVIII A3 152 75</p>	 <p>XIX A3 152 76</p>	 <p>XX A3 152 78</p>
 <p>XXI A3 152 79</p>	 <p>XXII A3 152 87</p>	 <p>XXIII A3 152 88</p>	 <p>XXIV A3 152 89</p>



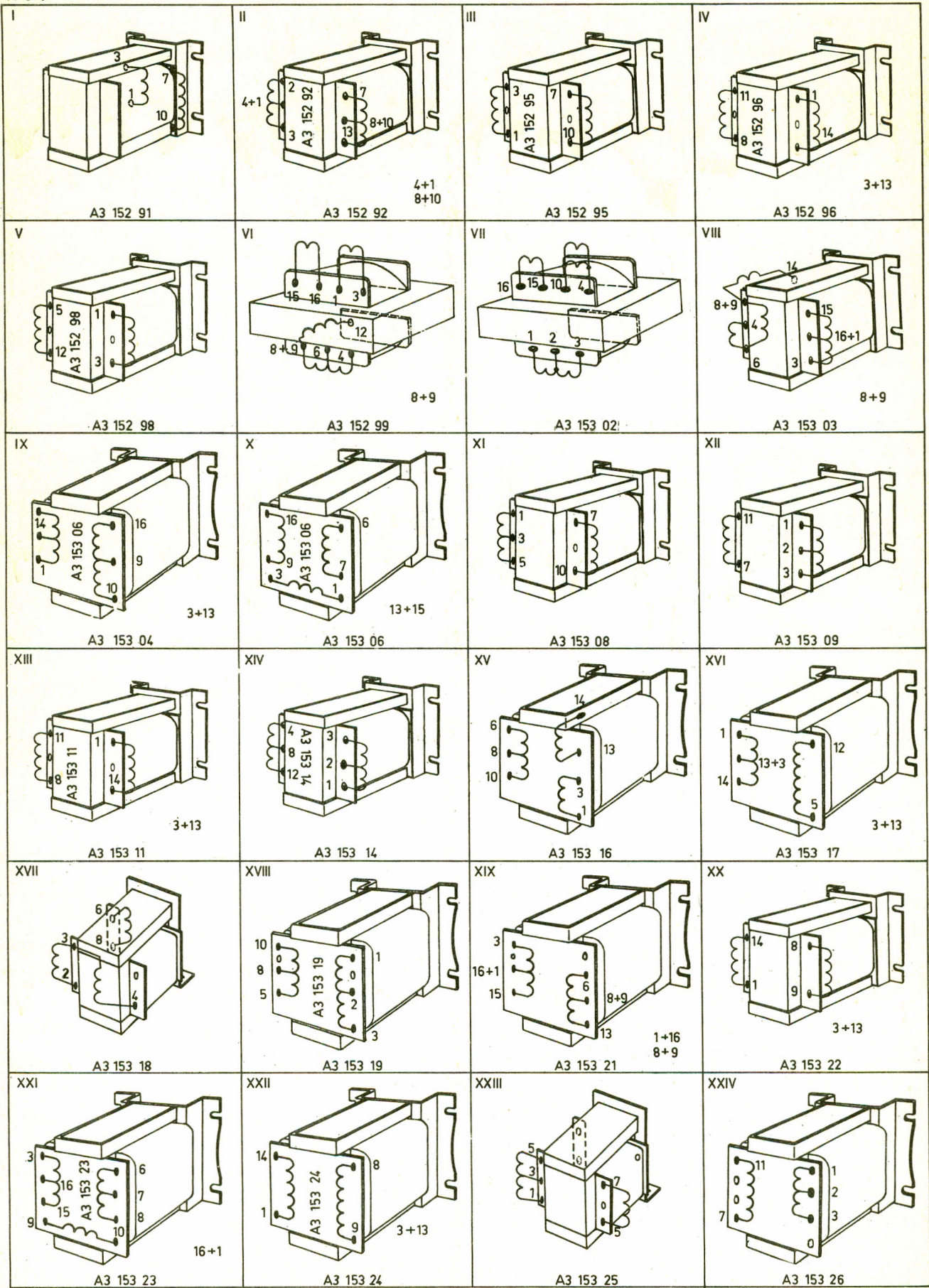



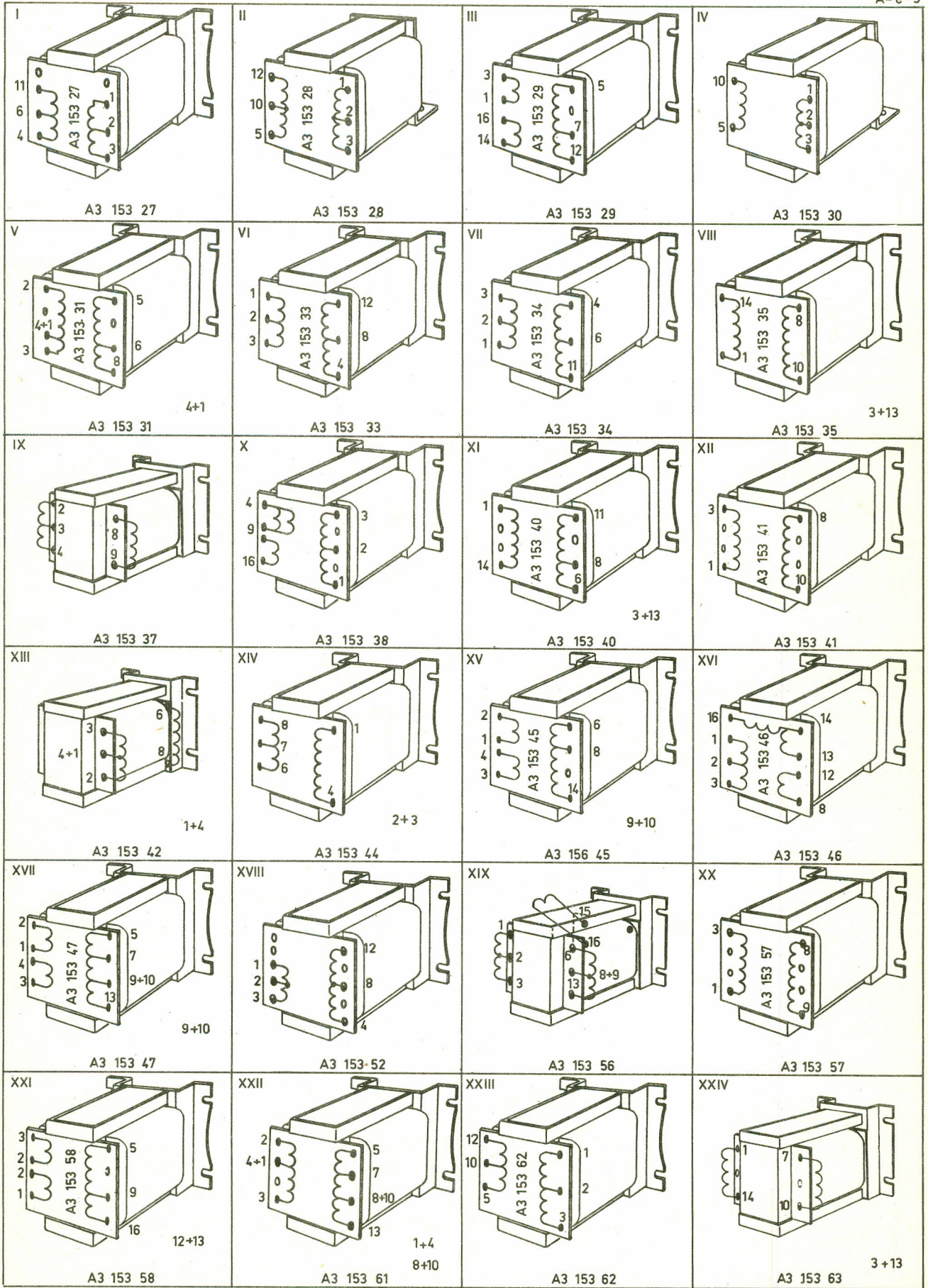



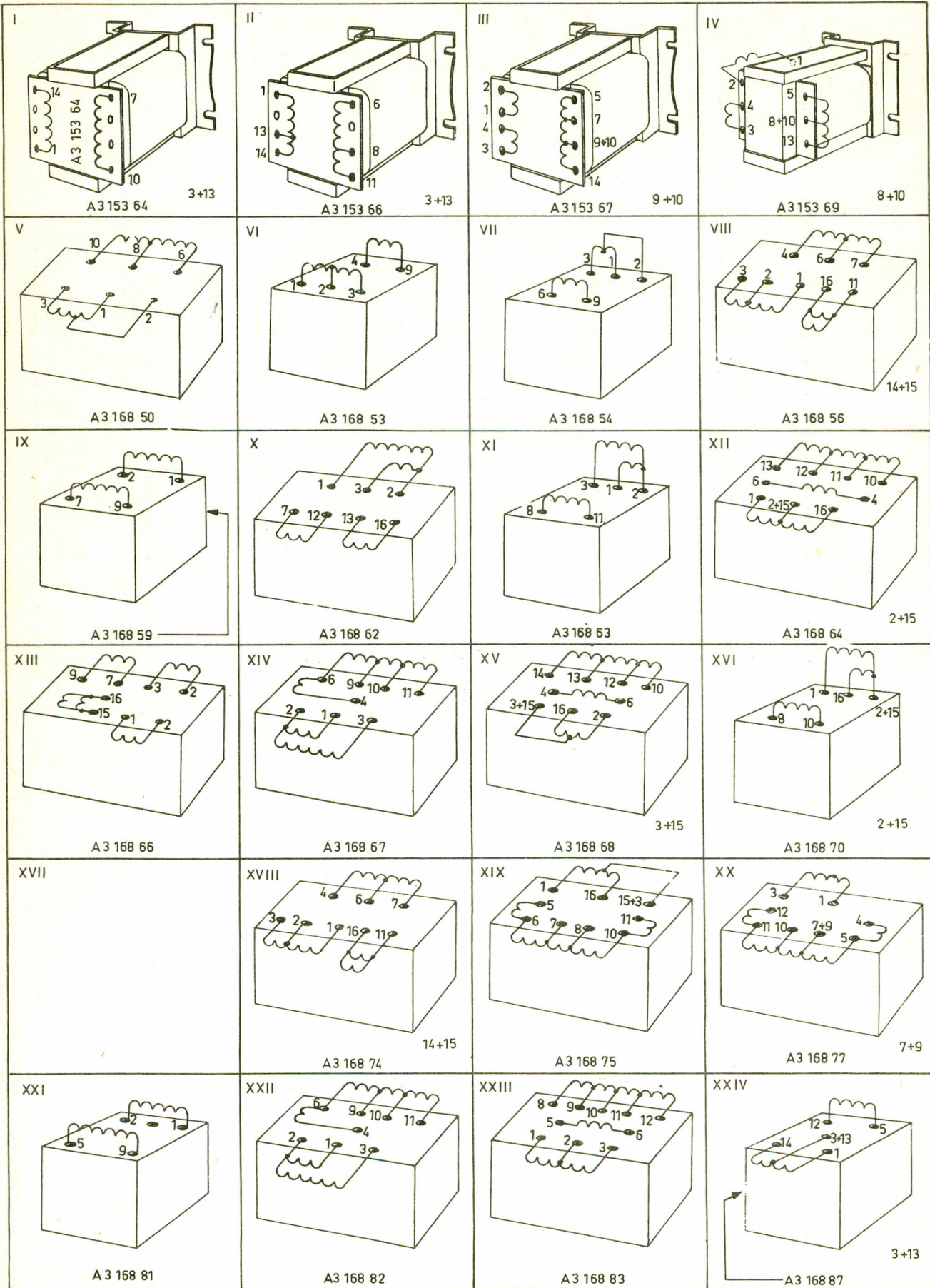



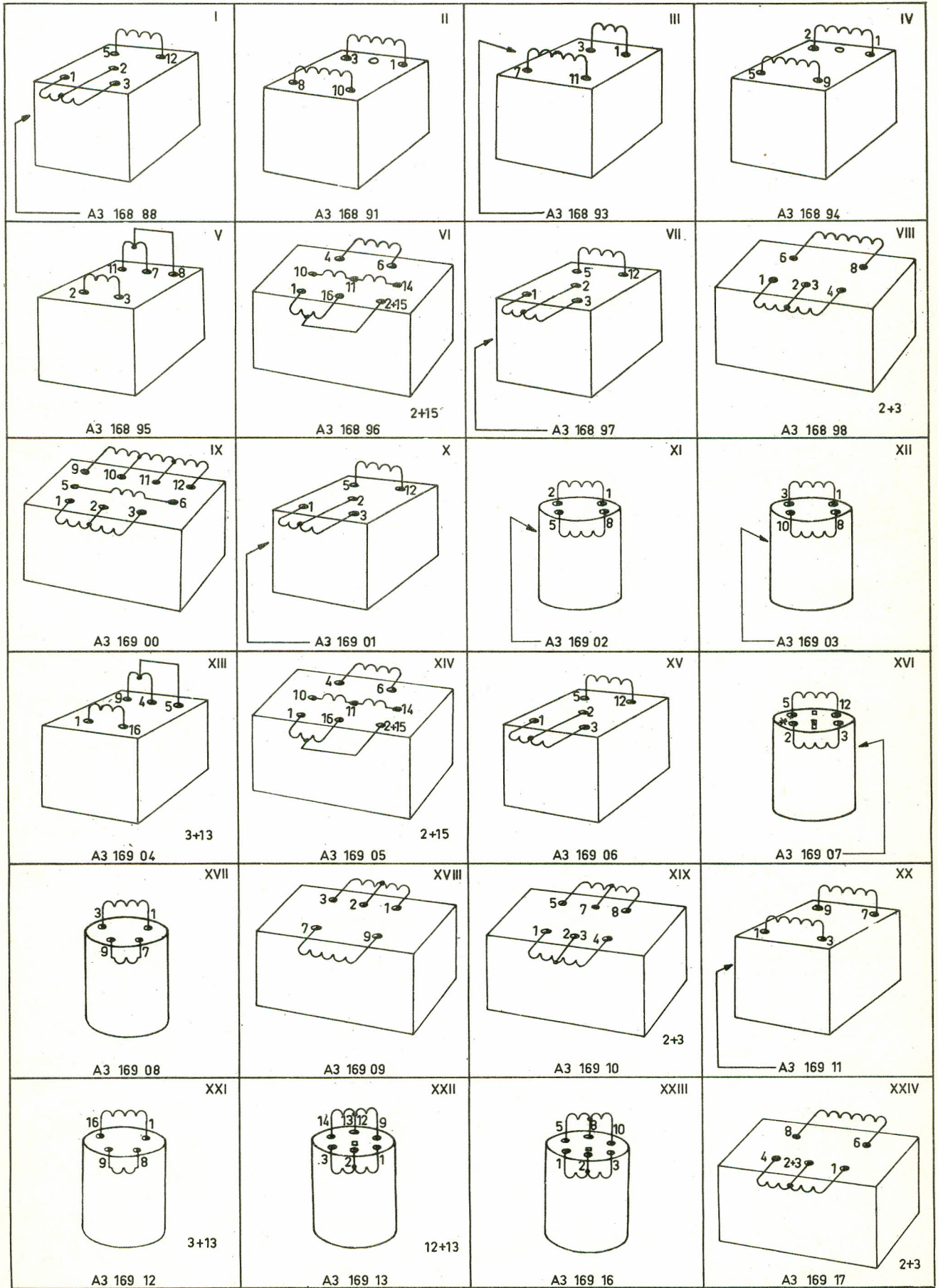



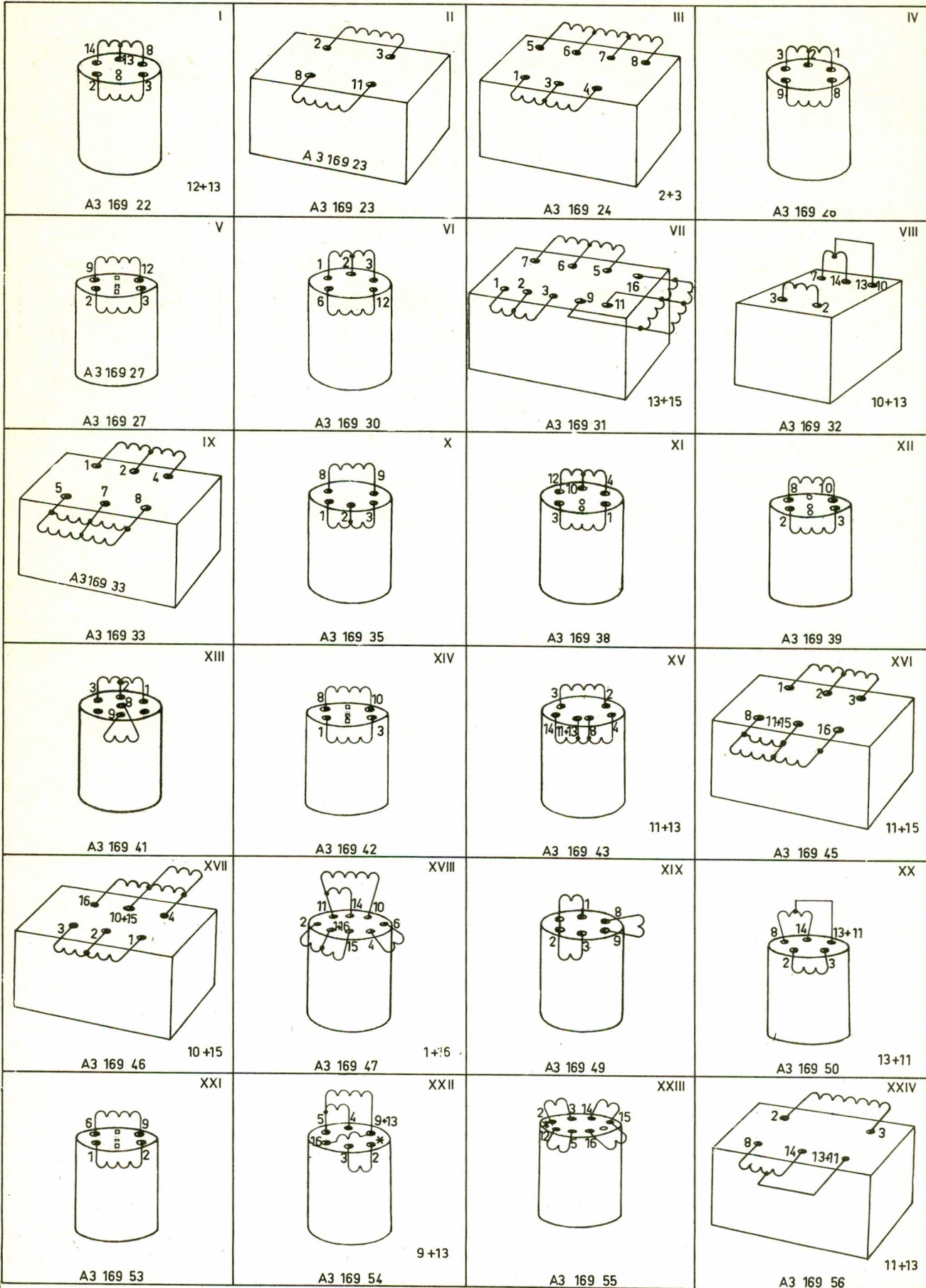



<p>I</p> <p>A3 169 57</p> <p>8+9 1+16</p> <p>A 3 169 57</p>	<p>II</p> <p>A 3 169 58</p>	<p>III</p> <p>A3 169 59</p> <p>3+15 6+12</p> <p>A3 169 59</p>	<p>IV</p> <p>A3 169 60</p> <p>12+13</p> <p>A 3 169 60</p>
<p>V</p> <p>A3 169 61</p> <p>A 3 169 61</p>	<p>VI</p> <p>A3 169 62</p> <p>A 3 169 62</p>	<p>VII</p> <p>A3 169 63</p> <p>A 3 169 63</p>	<p>VIII</p> <p>A3 169 64</p> <p>10+15</p> <p>A 3 169 64</p>
<p>IX</p> <p>A3 169 65</p> <p>A 3 169 65</p> <p>12+13</p>	<p>X</p> <p>A3 169 66</p> <p>A 3 169 66</p>	<p>XI</p> <p>A3 169 67</p> <p>12+13</p> <p>A 3 169 67</p>	<p>XII</p> <p>A3 169 69</p> <p>A 3 169 69</p>
<p>XIII</p> <p>A3 169 70</p> <p>A 3 169 70</p> <p>8+14</p>	<p>XIV</p> <p>A3 169 71</p> <p>A 3 169 71</p> <p>1+16 9+8</p>	<p>XV</p> <p>A3 169 72</p> <p>A 3 169 72</p>	<p>XVI</p> <p>A3 169 73</p> <p>A 3 169 73</p>
<p>XVII</p> <p>A3 169 75</p> <p>A 3 169 75</p>	<p>XVIII</p> <p>A3 169 77</p> <p>A 3 169 77</p>	<p>XIX</p> <p>A3 169 78</p> <p>A 3 169 78</p>	<p>XX</p> <p>A3 169 79</p> <p>A 3 169 79</p>
<p>XXI</p>	<p>XXII</p>	<p>XXIII</p>	<p>XXIV</p>







## PHILIPS SERVICE

Type nr. app.	Codenummer originele trafo
BX 115 B-00-01-02-91-92-95-98-99	A3 169 39
BX 115 U-00-01-50-62-63-67-91-92-95	A3 169 07
BX 115 U-17-19-69	A3 151 99
BX 125 B-97	A3 169 39
BX 135 B-00-63-70-72-75-92-95	A3 169 39
BX 135 U-00-01-02-62-63-70-71-72-73 -75-76-80-81-82-83-85-86-95-96	A3 169 07
BX 135 U-19-69	A3 151 99
BX 136 B-10	A3 169 78
BX 137 B-00-63-95	A3 153 24
BX 137 U-88-89-98-99	A3 169 07
BX 156 U-01	A3 169 07
BX 156 U-19-69	A3 151 99
BX 210 B-00-01-05-06-09-10	A3 152 52
BX 210 U-00-02-09-10-17-19-32-46-69	A3 151 99
BX 211 U	A3 151 99
BX 220 B-00-01-05-06-08-09	A3 152 52
BX 220 U-00-02-03-04-06-10-19-69-79-89-99	A3 151 99
BX 221 U-04-06-09-10-66-70-79-89-99	A3 151 99
BX 230-00-05	A3 152 52
BX 230 U-00-19-32-99	A3 151 99
BX 236 B-63-71-72-75-77-95	A3 169 78
BX 236 B-97	A3 153 24
BX 236 U-62-63-72-73-75-76-95-96	A3 169 07
BX 242 A-00-01	A3 153 42
BX 250 B	A3 153 24
BX 250 B-01	A3 152 52
BX 250 U-00-01-04	A3 151 99
BX 310 A-00-01-02-03-04-05-09-10-14 -32-39-46-50-51-53-54-59-60 -68-69-90-94-95-96	A3 152 18
BX 310 U-00-02	A3 152 37





## PHILIPS SERVICE

Type nr.app.	Codenummer originele trafo
BX 311 A	A3 152 18
BX 311 U	A3 152 37
BX 313 A	A3 152 18
BX 315 U	A3 169 07
BX 316 B-00-01	A3 169 42
BX 316 U-00-02-07-09-10-50	A3 169 07
BX 317 U	A3 169 07
BX 320 A-00-04-17-19	A3 152 18
BX 320 A-01	A3 152 69
BX 320 U-01	A3 152 62
BX 321 A-00-10-12-19-50-51-64-69-89	A3 152 18
BX 323 B-00-01-02-05-06-08-09	A3 152 52
BX 323 U	A3 151 99
BX 326 B-00-01	A3 169 42
BX 326 U-00-02-03-04-06-10	A3 169 07
BX 327 U-04-06-10	A3 169 07
BX 328 B-00-01-02-08	A3 169 42
BX 328 U	A3 169 07
BX 329 B-00-01	A3 169 42
BX 330 A-00-12-19-32-64-69	A3 152 92
BX 332 A-00-04-09-11-12-13-14-16-19-32 -49-62-66-69-82-86-89	A3 151 99
BX 335 B-00 -04	A3 169 42
BX 335 U	A3 169 77
BX 350 A-00-32	A3 152 78
BX 351 A	A3 152 78
BX 352 B-00-01-02	A3 153 24
BX 355 B-00-01-02-04-05	A3 153 24
BX 355 U-00-04	A3 169 77
BX 357 B-00-01-02	A3 153 24
BX 410 A-00-02-17-19-20-32-40	A3 152 29
BX 410 A-22	A3 151 74

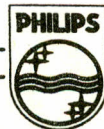



## PHILIPS SERVICE

Type nr.app.	Codenummer originele trafo
BX 410 Z	A3 152 29
BX 411 A	A3 151 15
BX 416 A-00-02-03-21-50-52-53-71-90-91	A3 169 22
BX 416 Z-00-21-90-91	A3 169 22
BX 420 A-01-02-03-06-19-20	A3 152 18
BX 423 B-00-01-05-06	A3 152 40
BX 425 A	A3 169 22
BX 425 Z	A3 169 22
BX 426 A-00-50-71	A3 169 22
BX 426 U	A3 169 47
BX 426 Z-00-15-71	A3 169 22
BX 427 A-00-10	A3 169 22
BX 427 U	A3 169 47
BX 427 Z	A3 169 22
BX 428 A	A3 169 22
BX 428 B-00-01	A3 169 35
BX 429 B	A3 169 35
BX 430 A-10-12-19-50	A3 152 78
BX 433 A-00-02-16-19-38-54	A3 152 78
BX 435 A-11	A3 169 65
BX 435 Z	A3 169 65
BX 439 B-00-05-10	A3 169 35
BX 439 V	A3 169 35
BX 443 A-00-02	A3 152 78
BX 449 A	A3 169 71
BX 449 B-00-05	A3 169 35
BX 450 A	A3 152 78
BX 453 A-00-19-90-91	A3 152 78
BX 454 A-00-90	A3 152 78
BX 455 A	A3 169 65
BX 455 Z	A3 169 65
BX 459 A	A3 169 71

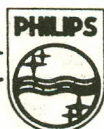



## PHILIPS SERVICE

Type nr. app.	Codenummer originele trafo
BX 459 A-08-10	A3 169 35
BX 459 A-01	A3 153 25
BX 459 U-	A3 169 35
BX 510 A-	A3 151 93
BX 510 A-01	A3 151 71
BX 511 A-00-20	A3 151 93
BX 514 U-	A3 151 95
BX 515 AU-00-11	A3 168 77
BX 516 A-02-10-21	A3 169 32
BX 516 Z-00-21	A3 169 32
BX 520 A-00-01-09-19-46	A3 152 18
BX 523 A	A3 152 18
BX 524 A-00-16	A3 152 67
BX 525 A	A3 169 22
BX 525 Z	A3 169 22
BX 526 A-00-15-21	A3 169 22
BX 526 U	A3 169 47
BX 526 Z-00-21	A3 169 22
BX 527 Z	A3 169 22
BX 531 A-21	A3 169 58
BX 533 A-00-19-38	A3 152 78
BX 534 A-12-14-32-38-50	A3 169 58
BX 535 A-10-12	A3 169 57
BX 536 A-00-58	A3 169 57
BX 536 Z	A3 169 59
BX 539 A	A3 169 57
BX 543 A-02-19-54	A3 152 99
BX 548 A-00-54	A3 169 71
BX 549 A-	A3 169 71
BX 555 A-	A3 169 57
BX 555 Z-	A3 169 57
BX 558 A-	A3 153 45
BX 610 A-00-16-17-19-20-29-40-46-48-59	A3 152 02
BX 616 A-00-11	A3 168 75
BX 620 A-00-03-19-32	A3 152 57
BX 624 A	A3 169 43
BX 626 A-00-02-04-10	A3 169 43
BX 626 U-	A3 169 47
BX 626 Z	A3 169 43
BX 630 A	A3 169 58
BX 632 A-19-32-50	A3 169 58
BX 633 A-00-16-19-32-38-59-69	A3 152 78
BX 634 A-00-01	A3 152 67
BX 638 A-	A3 169 57
BX 638 U	A3 169 47

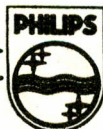



## PHILIPS SERVICE

Type nr. app.	Codenummer originele trafo
BX 638 Z	A3 169 59
BX 640 A-00-59	A3 153 09
BX 642 A-00-16	A3 153 14 + A3 152 99
BX 642 A-19	A3 153 47 + A3 153 14
BX 642 A-38-	A3 152 99 + A3 153 14
BX 643 A-00-02-16-19	A3 152 99
BX 645 A-00-60-65	A3 169 57
BX 645 U	A3 169 47
BX 653 A-00-16-38	A3 153 09
BX 659 B	A3 152 99
BX 716 X-01-51	A3 169 17
BX 717 X-	A3 169 33
BX 718 X-00-51	A3 169 17
BX 719 X	A3 169 45
BX 722 A	A3 152 19
BX 735 A-00-21	A3 169 60
BX 738 A-	A3 169 67
BX 740 A-00-16-19	A3 152 99
BX 745 A-00-21-60-65	A3 169 60
BX 750 A-00-16-19-38	A3 152 99 + A3 153 09
BX 755 A	A3 153 29 + A3 153 30
BX 756 A	A3 153 29 + A3 153 30
BX 758 A	A3 153 30 + A3 153 47
BX 759 A-54	A3 153 14 + A3 153 47
BX 822 A-10	A3 152 63
BX 998 A-00-16-19-29-32-38-54-74	A3 169 72 + A3 152 98
FX 551 A-00-90	A3 152 78
FX 552 A-00-90	A3 152 78
FX 557 A-00-10-60	A3 169 71
FX 611 A	A3 152 29
FX 612 A	A3 151 15
FX 613 A-00-20	A3 152 29
FX 613 A-20-49-69-70-71-79-89	A3 152 29
FX 614 A	A3 152 29
FX 615 A	A3 168 63
FX 617 A-00-03-05-06-08-10-12-51-66	A3 169 32
FX 617 AU-00-05	A3 169 32
FX 618 A-00-03-05-08-10-29-58	A3 169 32
FX 619 A	A3 169 32
FX 624 A	A3 152 67
FX 631 A-00-01- 54-99	A3 152 78
FX 637 A	A3 169 57
FX 637 AU-00-10-56	A3 169 59
FX 641 A	A3 152 99 + A3 153 14

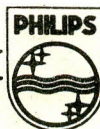



## PHILIPS SERVICE

Type nr. app.	Codenummer Originele trafo
FX 651 A	A3 152 99 + A3 153 09
FX 651 A-90-92	A3 153 09
FX 652 A	A3 152 99 + A3 153 09
FX 652 A-90-92	A3 153 09
FX 656 A-00-01-02-10-60-61-62	A3 153 29 + A3 153 30
FX 657 A-00-01-61-	A3 153 29 + A3 153 30
FX 614 A-00-05-07-10-16-20-30-50	A3 152 02
FX 723 A-03-054-60	A3 152 64
FX 723 A-90-91-96-97	A3 153 38
FX 727 A-00-02-06-10	A3 169 45
FX 727 X-00-02	A3 169 45
FX 737 A-00-10-60-66	A3 169 60
FX 741 A-	A3 153 03
FX 742 A	A3 153 03
FX 743 A-00-54	A3 153 99 + A3 153 14
FX 744 A-00-54	A3 152 99 + A3 153 14
FX 744 A-90-94	A3 152 99 + A3 153 14
FX 744 A-00-60	A3 169 60
FX 748A-00-16	A3 153 28
FX 749 A-00-02-03-06-10-60-66-62-63	A3 153 28
FX 814 A-00-19-32-50	A3 152 19
FX 819 A-00-08-10-50-60	A3 169 17
FX 819 X-00-05-29-50	A3 169 17
FX 824 A-00-02-19-32-54-56-60	A3 152 60
FX 824 A-90-96	A3 153 02
FX 829 A-00-08-10	A3 169 46
FX 829 X-	A3 169 46
FX 839 A-00-10-56-66	A3 169 64
FX 840 A-00-19-29-32-54-60	A3 152 64
FX 840 A-90-91-96-97	A3 153 38
FX 845 A-00-10	A3 169 60
FX 847 A-	A3 169 60
FX 995 A-00-03-04-19-63-64-69	A3 169 79 + A3 152 98
FX 997 A-00-03-04-19-63-64-69	A3 169 79 + A3 152 98
HX 347 A-00-01-02-03-60-61-62-63-64-65-92-93-96-98	
	A3 169 77
HX 347 A-05-19-69	A3 151 99
HX 348 A-00-01-60-61	A3 169 77
HX 348 A-02-03-19-69-79-89-92-93	A3 151 99
HX 424 A-00-03-04-06-19	A3 151 99
HX 428 A-00-02-03-10	A3 169 07
HX 454 A-00-01	A3 369 07
HX 458 A-00-01-60-61	A3 169 07
HX 511 A-00-01-20-71	A3 152 29
HX 513 A-00-02-30-70	A3 152 29

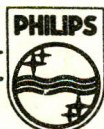



## PHILIPS SERVICE

Type nr. app.	Codenummer Original trafo
HX 514 A-00-20	A3 152 29
HX 518 A-00-03-05-08-10-30-38	A3 169 32
HX 523 A-00-01-20	A3 152 18
HX 528 A-00-01-03-60	A3 169 22
HX 531 A	A3 169 58
HX 532 A-00-16	A3 169 58
HX 538 A-00-10-60	A3 169 57
HX 539 A-	A3 169 57
HX 543 A-00-16	A3 152 78
HX 553 A-	A3 152 78
HX 558 A-00-10-60	A3 169 57
LX 422 AB-00-19-29-32-40-49	A3 152 44
LX 422 AB-49-69-89	A3 152 44
LX 423 AB	A3 152 44
LX 432 AB	A3 152 74
LX 434 AB-00-32-69-89	A3 152 74
LX 437 AB-	A3 169 62
LX 444 AB-01-02-03-04	A3 152 74
LX 527 AB-00-01-08-10-11-19-32-69-	A3 169 35
LX 548 AB-00-19	A3 169 35
B1X68B-00-63-70-72-95	A3 153 24
B1X68U-00-01	A3 169 07
B2X60B-	A3 153 22
B2X67B-62-95-97	A3 153 24
B2X67BT-62-95-97	A3 153 25
B2X68B-63-72-82	A3 169 78
B2X68B-97	A3 153 24
B3X62B-	A3 153 24
B3X63A-00-19	A3 152 92
B3X65BT	A3 153 25
B3X66B-00-04-13-80	A3 153 24
B3X66BT-	A3 153 25
B3X67B-	A3 153 24
B3X67BT	A3 153 25
B3X69A	A3 153 45
B3X71BT	A3 153 25
B3X67BT	A3 153 25
B4X61A-00-19	
B4X64A-	A3 163 69
B4X65A	A3 153 45
B4X67A	A3 169 65
B4X67Z	A3 169 65
B4X69A	
B4X71BT	A3 153 25

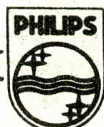



## PHILIPS SERVICE

Type nr. app.	Code nummer originele trafo
B4X72A-00-13	A3 153 69
B4X73A	A3 152 92
B4X76BT	A3 153 25
B4X77A	A3 152 92
B5X65Z	A3 169 65
B5X66A	A3 153 34
B5X75A	A3 153 45
B6X62A-00-06-19-32-52-	A3 153 62 + A3 153 47
B6X63A-00-19-32-38	A3 153 62 + A3 153 47
B6X79B	A3 169 35
B7X65A	A3 153 29 + A3 153 30
F5X61A-00-01-54	A3 153 62 + A3 153 47
F6X62A-	A3 153 62 + A3 153 47
F6X63A-00-59	A3 153 14
F6X66A-01-61-62	A3 153 29 + A3 153 30
F6X67A-01-61-62	A3 153 29 + A3 153 30
F7X64A-04-64	A3 153 62 + A3 153 47
F7X65A-00-01-04-61-64	A3 153 28
F7X66A-04-64	A3 153 28
H4X64A-00-01	A3 152 92
H4X68A-00-60	A3 153 45
H4X74A-00-01	A3 153 61
H4X75BT	A3 153 25
H5X68A-00-60	
H5X75A	A3 153 67
L3X71T	A3 153 25
L4X60BT-00-04-	A3 153 25
L4X65BT-00-04-	A3 153 25
L4X70BT-	A3 153 25
N3X64V	A3 153 63
N3X66V	A3 153 64
N5X64V	A3 153 52

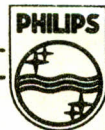



## PHILIPS SERVICE

Type nr. app.	Codenummer	Originele trafo
MD 1000 B-01	A3	153 24
MD 1007 U-16-66	A3	169 07
MD 1051 U	A3	169 07
MD 1057 B-04-72	A3	169 78
MD 1057 B	A3	153 24
MD 1057 U-04-62-63	A3	169 07
MD 1501 B-00-01-05-06	A3	152 52
MD 1501 U-00-10-79-99	A3	151 99
MD 1502 U	A3	151 99
MD 1504 B	A3	169 39
MD 1504 U	A3	169 07
MD 1504 U-01-71-	A3	169 07
MD 1504 U-19-69	A3	151 99
MD 1504 U-70	A3	169 57
MD 1507 U-00-01	A3	169 07
MD 1507 U-19-69-89-99	A3	151 99
MD 1508 B-00-05	A3	152 52
MD 1508 U-00-19-99	A3	151 99
MD 1510 U-	A3	151 99
MD 1551 B-00-04	A3	169 42
MD 1551 U-00-10	A3	169 07
MD 1557 B-63-72	A3	169 78
MD 1557 U-62-63	A3	169 07
MD 1558 B-	A3	169 42
MD 1558 U	A3	169 07
MD 2002 A-19	A3	152 18
MD 2063 A-07	A3	169 65
MD 2063 Z-00-07	A3	169 65
MD 2502 A-00-50-64	A3	152 18
MD 2502 U-	A3	152 62
MD 2510 B-00-05	A3	152 52
MD 2552 A	A3	169 22
MD 2552 U-	A3	169 47
MD 2552 Z	A3	169 22
MD 2553 A	A3	169 22
MD 2556 A	A3	169 65
MD 2562 Z	A3	169 65
MD 3502 A-00-50	A3	152 18
MD 3524 A-19	A3	152 99
MD 3529 A-16		
MD 3551 A	A3	169 22
MD 3552 A	A3	169 22
MD 3552 Z	A3	169 22
MD 4006 A	A3	169 57
MD 4056 A	A3	169 57

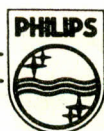



## PHILIPS SERVICE

Type nr. app.	Codenummer Originele trafo
MD 4556 A	A3 169 57
MD 6555 AB-00-69-89	A3 152 74
MD 6556 AB-00-65	A3 152 74
MD 7501 V-06-12	A3 152 48
MD 7502 V-06-12	A3 153 19
MD 7551 V-	A3 169 38
MD 7552 V-06-12	A3 153 19
MD 8505 A	A3 151 99
MD 8506 A	A3 169 58
MD 8509 A	A3 169 58
NX 344 V-00-10-12-17-22	A3 152 96
NX 346 V-00-02-10-54	A3 153 11
NX 524 V-06-12	A3 152 48
NX 526 V-06-12	A3 169 38
NX 527 V-06-12	A3 169 38
NX 554 V-06-12	A3 152 48
NX 556 V-06-12	A3 169 38
NX 624 V-06-12-24	A3 152 47
NX 626 V-06-12	A3 169 16
NX 627 V-06-12	A3 169 16
NX 634 V-06-12-24	A3 153 19
NX 636 V-06-12	A3 153 19
NX 644 V-00-01	A3 163 19
NX 646 V-	A3 153 19
NX 713 V	A3 152 06
NX 724 V-00-24	A3 152 47
NX 726 V-	A3 152 47
NX 744 V-00-01	A3 153 19
SA 1000 B-63-75	A3 169 39
SA 1000 B-01-64-69	A3 153 24
SA 1000 U-00-01-62-63-70-71-72-73- 75-76-95-96	A3 169 07
SA 1000 U-19-69-98-99	A3 151 99
SA 1001 B-00-01-05-06	A3 152 52
SA 1001 U-00-10-79-89-99	A3 151 99
SA 1007 U-00-01-	A3 169 07
SA 1007 U-19-69-89-99	A3 151 99
SA 1010 B-00-05-36	A3 152 52
SA 1010 U-00-10-19-32-36-79-99	A3 151 99
SA 1014 B-00-36	A3 153 24
SA 1014 B-01	A3 152 52
SA 1014 U-00	A3 151 99
SA 1051 B-01	A3 169 42

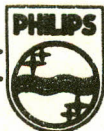



## PHILIPS SERVICE

Type nr. app.	Code nummer Originele trafo
SA 1051 U-00-10	A3 169 07
SA 1057 B-63-72-75-77	A3 169 78
SA 1057 U-62-63-95+96	A3 169 07
SA 1059 B-95-97	A3 153 25
SA 1060 B-00-04	A3 169 42
SA 1060 U	A3 169 77
SA 1064 B-00	A3 153 24
SA 1064 B-01	A3 169 42
SA 1064 U-	A3 169 77
SA 1080 B-00-59	A3 153 24
SA 1501 U-00-99	A3 151 99
SA 1507 U-89	A3 151 99
SA 2002 A-32-50-64	A3 152 18
SA 2002 U	A3 152 62
SA 2010 B-00-05-36	A3 152 52
SA 2011 B	A3 152 52
SA 2012 A-32-64	A3 152 92
SA 2012 A-36	A3 152 78
SA 2013 A-00-32	A3 152 78
SA 2014 A-64	A3 152 18
SA 2014 B-00-01	A3 153 25
SA 2024 A-00-09	A3 152 78
SA 2025 A	A3 152 78
SA 2026 A-00-64	A3 152 78
SA 2029 A-00-52	A3 152 92
SA 2030 B-00-10-12	A3 153 24
SA 2039 A-	A3 153 45
SA 2052 A	A3 169 22
SA 2052 U	A3 169 47
SA 2052 Z	A3 169 22
SA 2060 B-00-02	A3 169 42
SA 2061 B	A3 169 42
SA 2062 A	A3 169 65
SA 2062 A	A3 169 65
SA 2062 Z	A3 169 65
SA 2063 A	A3 169 65
SA 2063 Z	A3 169 65
SA 2064 A	A3 169 22
SA 2064 B-00	A3 153 24
SA 2064 B-01	A3 169 42
SA 2066 A	A3 169 71
SA 2068 B-00-01	A3 169 35
SA 2073 A	A3 169 65
SA 2073 Z	A3 169 65
SA 2080 B-00-12	A3 153 24

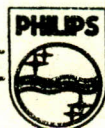



## PHILIPS SERVICE

Type nr. app.	Codenummer Originele trafo
SA 2089 A	A3 153 45
SA 2502 A-19	A3 152 18
SA 2552 A-00-21	A3 169 22
SA 2552 Z	A3 169 22
SA 3002 A-00-32-50	A3 152 18
SA 3008 A-13	A3 153 69
SA 3010 A	A3 152 92
SA 3013 A-00-32	A3 152 78
SA 3014 A-64-	A3 152 18
SA 3016 A-38	A3 152 78
SA 3024 A-00-19	A3 152 99
SA 3040 A	A3 153 61
SA 3052 A	A3 169 22
SA 3052 Z	A3 169 22
SA 3060 B	A3 169 35
SA 3063 A	A3 169 65
SA 3064 A	A3 169 22
SA 3066 A	A3 169 71
SA 3552 A	A3 169 22
SA 4003 A-00-12	A3 169 58
SA 4006 A-	A3 169 57
SA 4027 A-00-32	A3 153 62 + A3 153 47
SA 4055 A	A3 153 45
SA 4056 A	A3 169 57
SA 6006 AB-00-19	A3 152 74
SA 6007 BT-	A3 153 25
SA 6055 AB-00-89	A3 152 74
SA 6056 AB-00-64-65	A3 152 74
SA 6056 AB-01-	A3 169 62
SA 6057 BT	A3 153 25
SA 7001 V-06-12	A3 152 48
SA 7002 V-06-12	A3 153 19
SA 7010 V	A3 153 52
SA 7051 V-06-12	A3 169 38
SA 7052 V-06-12	A3 153 19
SA 8004 A	A3 152 64
SA 8005 A	A3 151 99
SA 8006 A	A3 169 58
SA 8009 A	A3 169 58
SA 8013 A-	A3 153 61
SA 8020 A-00-01	A3 153 61
SA 8041 A-	A3 152 99 + A3 153 14
SA 8085 A-00-01-61	A3 153 67

HT/GH

